



TYPE 85UVF/IRF Integrated Flame Scanner with Internal Flame Relay



SEE TABLE 1 ON PAGE 3

DESCRIPTION

The Fireeye Phoenix type 85UVF/IRF flame scanners are microprocessor based devices utilizing a solid state flame detection sensor. The Phoenix flame scanners incorporate an internal flame relay with automatically set ON/OFF thresholds, thereby eliminating the need for a remote flame amplifier or flame switch.

Phoenix scanners detect the amplitude of the modulations (the flame “flicker”) that occur within the targeted flame, over a wide frequency. During the scanner setup procedure, the amplitudes of the target flame are automatically stored by the flame scanner, together with optimum ON/OFF criteria. The appropriate sensor gain is automatically selected. Phoenix scanners incorporate full self diagnostics and electronic self checking.

The Phoenix 85UVF/IRF is available in multiple models differentiated by detection cell type, levels of hazardous area certifications and agency approvals. Refer to Table 1 on page 3 for an overview of model numbers versus product certifications.

The Phoenix 85UVF/IRF flame scanner is powered by 24Vdc and includes an integral 10-foot (3 meter) captive cable. An analog 4 to 20mA output of flame strength is standard.

APPLICATION

Fireeye Phoenix 85UVF self-checking scanners are used to detect 295 to 340 nanometers wavelength ultra-violet emissions.

Typical Applications: Duct Burners, Industrial Gas Burners, Refinery Applications, Low NO_x Burners, Waste Gas Units and Incinerators.

Fireeye Phoenix 85IRF self checking scanners are used to detect 830 to 1100 nanometers wavelength infra-red emissions. They are suited for application to duct burners, industrial gas burners, refinery applications ignition systems and Low NO_x detection and for continuous or non-continuous burner operation.

Typical Applications: Duct Burners, Industrial Oil Burners, Refinery Applications, Waste Oil Units and Incinerators.

NOTE: *Because the sensors in the Phoenix are solid state devices they can perform well with many different fuels. For example UV is typically used on gaseous fuels but can also be applied to oils and heavy oils. To be 100% sure of correct application a test should be performed.*

We DO NOT recommend the Phoenix scanner for use on small pilot flames or obstructed sighting.

OPERATOR & SYSTEM INTERFACE

Operator interface to the Phoenix scanner is via a pushbutton keypad and informative LEDs. These provide continuous indication of flame signal, flame relay status, scanner status as well as selected mode of operation. Simplified keystroke routines are used for setup and this can be completed in seconds. For remote interface, outputs are provided for flame switch, fault relay and 4 to 20mA flame strength.

SPECIFICATIONS

FIGURE 1. DIMENSIONS

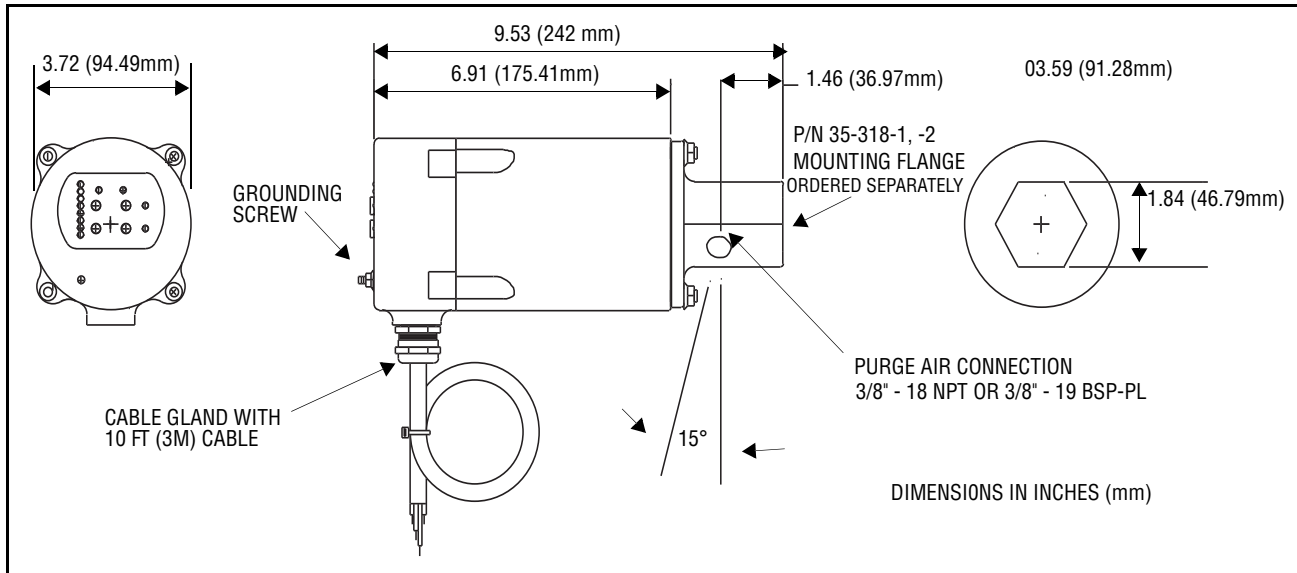
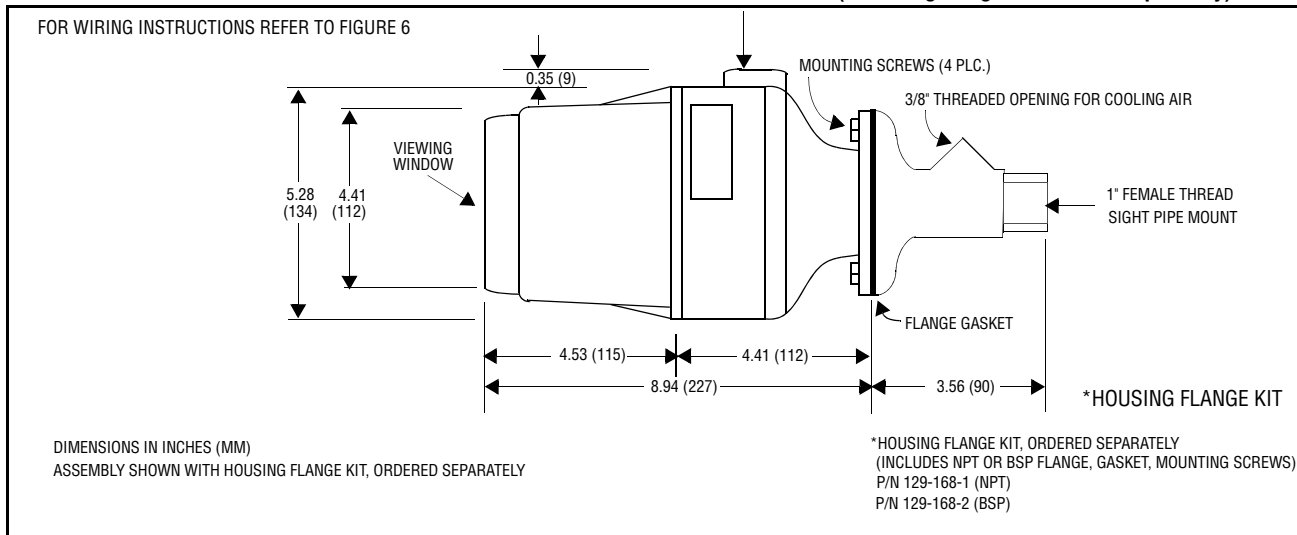

FIGURE 2. PHOENIX SCANNER in CENELEC HAZARDOUS AREA HOUSING (mounting flange kit ordered separately)



All models of the Phoenix 85UVF1/IRF1-1CEX flame scanners are housed within a CENELEC and ATEX approved housing for application in EExd IIC T6 hazardous rated environment. In addition the CENELEC housing is designed to meet the requirements of IP66 (NEMA 4X).



SCANNER PART NUMBERS AND APPROVALS

Table 1:

SCANNER MODEL	AGENCY APPROVALS										ATEX	
	FM	UL C/US	CE	CLASS I DIV 2	CLASS II DIV 2	CLASS III	NEMA 4x	IP66	DVGW	DIN CERTCO	Ex II 3 G/D EEx nA IIC T5	CENELEC EExd IIC T6
85UVF1-1	X	X	X				X	X	X	X	X	
85UVF1-1EX	X	X	X	X	X	X	X	X	X	X	X	
85UVF1-1CEX			X					X	X	X		X
85IRF1-1	X	X	X				X	X	X	X	X	
85IRF1-1EX	X	X	X	X	X	X	X	X	X	X	X	
85IRF1-1CEX			X					X	X	X		X
85IRF1-2	X	X	X				X	X	X	X	X	
85UVF1-2	X	X	X				X	X	X	X	X	
85IRF1-2EX	X	X	X	X	X	X	X	X	X	X	X	
85UVF1-2EX	X	X	X	X	X	X	X	X	X	X	X	

X = CERTIFICATION IN HAND

CE = 90/396/EEC Gas Appliance directive-EN298
Oil Burning Applications-EN230

ACCESSORIES

PART NUMBER	DESCRIPTION
35-318-1	NPT MOUNTING THREAD MOUNTING FLANGE
35-318-2	BSP MOUNTING THREAD MOUNTING FLANGE
129-182-1	1" NPT INSIGHT FLANGE
129-182-2	1" BSP INSIGHT FLANGE

Fireye recommends the use of the P/N 35-127 Heat Insulating Nipple.

24 Volt DC Power Supplies

Fireye offers two DIN rail mounted 24 vdc power supplies for use with the Phoenix Integrated flame scanner. Model 60-2685-2 (2 amp) can power up to 10 Phoenix scanners, model 60-2685-4 (4 amp) can power up to 20 Phoenix scanners (*see note 1*). Refer to bulletin CU-100 for details

PART NUMBER	DESCRIPTION	NOTES
60-2685-2	24 VDC Switching Power Supply, 50W, 100-240 vac 50/60 Hz. input, 2.1 A output at 24 vdc. Dimensions: 3.2"(82mm) high x 3.5" (90mm) wide x 3.6"(91mm) deep	1, 2
60-2685-4	24 VDC Switching Power Supply, 100W, 120 / 240 vac 50/60 Hz. input, 4.2 A output at 24 vdc. Dimensions: 3.2"(82mm) high x 5.7" (145mm) wide x 3.6"(91mm) deep	1, 2
60-2539-12	DIN mounting rail, 12" (305mm)long	2
60-2539-24	DIN mounting rail, 24" (610mm)long	2
60-2539-36	DIN mounting rail, 36" (914mm)long	2

- Notes:**
1. Rated output is when power supply is vertically mounted, and with an ambient temperature of 122°F (50°C) maximum. When supply is mounted vertically, at 140°F (60°C) the output is de-rated 25%.
 2. When mounted in a row, allow at least 0.79" (20mm) between adjacent power supplies.



SPECIFICATIONS

MECHANICAL: [Basic models (-1), Hazardous locations model (-1EX),
Fiber Optic models (-2)]
Housing Material: Engineered material - GE Valox
Scanner Weight: 3.25 lbs (1.5kg)

ENVIRONMENTAL:

Temperature Rating: -40° F to + 150°F (-40°C to +65°C)
EX Model: -40° F to + 140°F (-40°C to +60°C)
Humidity: 0% to 95% relative humidity, non-condensing
Mounting Flange: P/N 35-318-1, 1" NPT female pipe mount flange with
(Ordered Separately) 3/8" NPT female cooling air connection
P/N 35-318-2, 1" BSP female pipe mount flange with
3/8" BSP female cooling air connection
P/N 129-182-1, 1" NPT Insight mounting flange
P/N 129-182-2, 1" BSP Insight mounting flange

COOLING/ PURGE AIR REQUIREMENTS:

Source: Clean, dry, cool
Volume: 4 SCFM (113 l/min) at 3/8" threaded mounting flange, or 1 inch
"Y" fitting, mounted on scanner sight pipe. Temperature near the upper limit
of the scanner operating range and/or use with dirty/dusty fuels may
require up to 15 SCFM (425 l/min).
Pressure: Adequate to overcome furnace or windbox pressure

ELECTRICAL:

Input Power: 24 Vdc nominal, +20%, -15% supply current 200 mA
Electrical Connection: Cable gland and 10 ft (3m) of captive cable
Relay Outputs: FLAME RELAY, SPST (N.O.)
FAULT RELAY, SPST (N.C.)
Contact Rating: Minimum: 10 mA @ 5 Vdc
Maximum: 2 A @ 30 Vdc, 2 A @ 230 Vac (Resistive load)
Analog Output: Optically isolated 4 to 20mA dc current referenced to 24Vdc common,
maximum connected load: 750 Ohms. Fireye recommends the 60-2685-X
24 VDC power supply for best performance and for a SELV rating of the
4-20mA analog output leads.
Status Indication: Multiple LED indication for flame signal strength, flame relay, ready,
target, background select and fault codes

MECHANICAL CEX MODELS:

Housing Material: EExd IIC T6 rated, ATEX certified, painted finish
Scanner Weight: 9.5 lbs (4.3kg)
Mounting Flange: P/N 129-168-1, female pipe mount with 3/8" NPT
(Ordered Separately) female cooling air connection
P/N 129-168-2, female pipe mount with 3/8" BSPPL
female cooling air connection.

OPTICAL: UV Models - 295 to 340 nanometers
IR Models - 830 to 1100 nanometers



INTEGRAL CABLE SPECIFICATION:

Basic Cable

Specification: P/N 59-497:

Multi-core, 12 conductor (4 unused) (color coded), with foil wrap and overall braided shield

Six #18 AWG and four #22 AWG conductors, plus one #22 AWG twisted pair

Cable Jacket: Irradiated Modified Polyolefin (flame-retardant, low smoke, zero halogen)

Nominal O.D. 0.41" (10.4 mm)

Maximum O.D. 0.43" (10.9 mm)

INSTALLATION NOTES

The Phoenix flame scanners determine the presence or absence of flame by monitoring the amplitude of the flame across a wide flicker frequency spectrum. The scanner should initially be mounted so that the primary combustion zone is within the scanner's line of sight.

The location and sighting instructions listed in the following sections are rough guidelines for the location of the scanner. The scanner provides feedback via LEDs and the 4-20ma output to assist in the adjustment and proper alignment of the flame scanner. Refer to the set-up procedures described in this bulletin.

Note: *An acceptable scanner location must ensure the following:*

Reliable main flame and/or ignitor flame detection at all air flow and furnace loads (ranges of fuel firing).

Rejection of the ignitor flame if too short or in the wrong position to ignite the main flame reliably, thus prohibiting the delivery of fuel to the burner.

Note: *Ensure the correct FFRT (Flame Failure Response Time) is selected prior to commissioning.*

INSTALLATION PROCEDURE



WARNING: Protective filtered lenses should be worn when viewing flame; infrared and ultraviolet energy from the flame can be damaging to the eyes.

1. The best results are obtained when the scanner is aimed so that the scanner's line of sight intersects the burner center at a slight angle (e.g. 5 degrees) and sees a maximum of the primary combustion zone, as shown in Figure 3. If only one scanner is used per burner, the line of sight should also intersect the igniting flame.
2. For installations where separate scanners are used to monitor main and ignitor flames, the main flame scanner should be sighted so it does not detect the ignitor flame.
3. The scanner should have an unrestricted view of flame as far as possible. Physical obstructions such as air register blades, interfering vanes, or other hardware should be cut away or notched so they do not fall within the scanner's line of sight as shown in Figure 3.

Note: *Always check with the burner manufacturer **before** you trim the register blades.*

FIGURE 3.

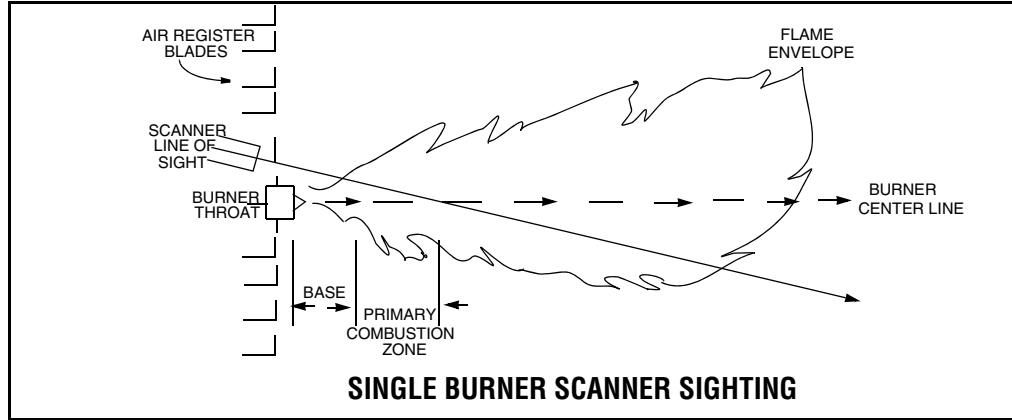

4. AN ACCEPTABLE SCANNER LOCATION MUST ENSURE THE FOLLOWING:
- Reliable pilot flame detection.
 - Reliable main flame detection.
 - Rejection of pilot flame too short or in the wrong position to ignite the main flame reliably, thus prohibiting main fuel admission.

Note: Reliable signals must be obtained at all air flows and furnace loads (ranges of fuel firing).

FIGURE 4.

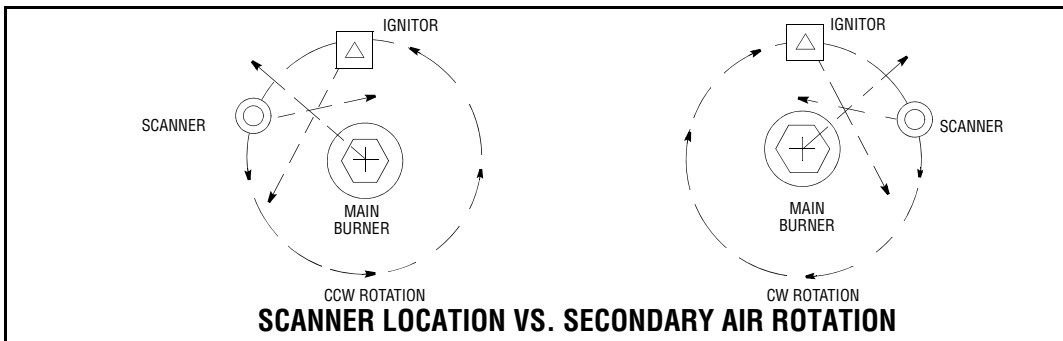

5. If combustion air enters the furnace with a rotational movement of sufficient velocity to deflect pilot flame in direction of rotation, position the scanner 0 to 30 degrees downstream of the pilot burner and close to the periphery of the throat where the ultraviolet radiation is at a maximum. (See Figures 3 and 4).

Having determined an appropriate location for the sight tube, cut a clearance hole for a 2 inch pipe through the burner plate. If register vanes interfere with the desired line of sight, the interfering vane(s) should be trimmed to assure an unobstructed viewing path at all firing levels, see example shown below.

*Note: Always check with the burner manufacturer **before** you trim register vanes.*

FLAME MUST COMPLETELY COVER SIGHT OPENING



6. The preferred method for mounting surface mounted scanners requires the use of a swivel mount, P/N 60-1664-3 (NPT), shown in Figure 5. Center the swivel mount over the two inch hole in the burner plate and secure using three hexed cap screws (not provided). Install the sight pipe on the swivel mount. If a swivel is not used, insert the end of the sight pipe into the hole, align the hole to the desired viewing angle and tack weld (welding must be adequate to temporarily support the weight of the installed scanner). The sight pipe should be arranged to slant downward so that dirt and dust will not collect inside.



CAUTION: Use no more than one foot of one inch diameter sight pipe. Increase the sight pipe diameter one inch for every additional foot of sight pipe length used to avoid restricting the scanner's field of view.

7. When a satisfactory sighting has been confirmed by operational testing, secure the swivel mount's ball position in place by tightening the three hex head cap screws located on the swivel mount ring.
8. For ease of use, the scanner should be installed on the sight pipe so the LED display can easily be read.

Note: Operation of the LED display is independent of position.

9. The scanner lens must be kept free of contaminants (oil, ash, soot, dirt) and the scanner housing temperature must not exceed its maximum rating of 150° F (65° C). Excessive temperatures will shorten scanner life. Both requirements will be satisfied by a continuous injection of purge air at either the 3/8" housing inlet or the 1" "Y" connection ahead of the swivel mount as shown in Figure 5.

The scanner mounting may be made with provision for purge air through only the 3/8" opening or for purge air through either the 3/8" opening or the 1" "Y" connection. In the latter arrangements, normally only one of the two connections is provided with purge air and the other connection is plugged. When a sealing union is used, the 1" "Y" connection is used for the purge air and the 3/8" opening is plugged.

It is good practice to use the sealing union (P/N 60-1199 with NPT threads) on all installations to insure against unwanted furnace pressures from damaging the scanner lens.

Under normal conditions, with clean burning fuels and moderate ambient temperature conditions, purge air flow of approximately 4 SCFM (133l/min) is generally adequate. Up to 15 SCFM (425 l/min) may be required for fuels that produce high levels of ash or soot, or for hot environments to maintain the scanner's internal temperature within specification.



CAUTION: To ensure safe and reliable detection it is the responsibility of the commissioning engineer to carry out flame failure testing after programming the scanner.

Ensure that the scanner correctly detects the target flame (Flame On condition) and recognizes the target flame off (Flame Off condition).

FIGURE 5.

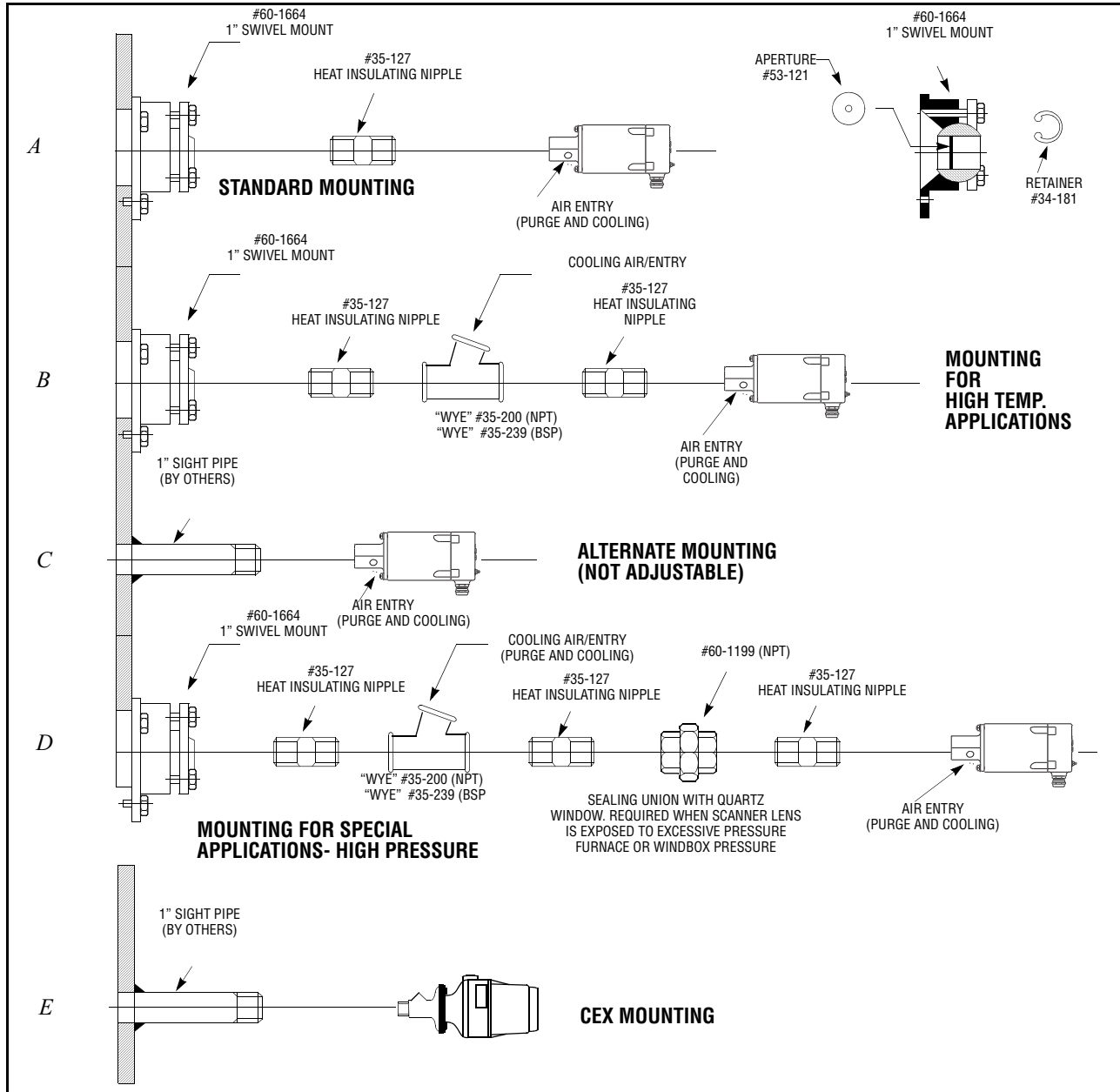

SCANNER WIRING

To reduce electrical noise interference, the scanner cable should be installed in flexible conduit. Take precautions to keep the scanner cable away from any high inductive wiring associated with high inductive loads or high voltage, high energy spark ignition systems.

EX models - wire per Div II wiring practices, install in flexible conduit only.



CAUTION: The Phoenix flame scanner requires 24 Vdc power for operation. Connection to a 24 Vac or 120 Vac power source will damage the scanner. Refer to wiring diagrams. External 2.0 Amp fuses are recommended to protect Flame Relay and Fault Relay contacts. All wiring to the scanner should be rated at 90°C. For runs less than 1000 feet, the use of Fireye Scanner Cable, P/N 59-497, (12 wire) is recommended. For runs in excess of 1000 feet, consult the factory.



CAUTION: The Phoenix flame scanner 4-20mA analog output is SELV rated only when the Phoenix is powered by an SELV rated 24 VDC power supply. The recommended Fireye 60-2685 power supply is SELV rated.

FIGURE 6. WIRING DIAGRAM

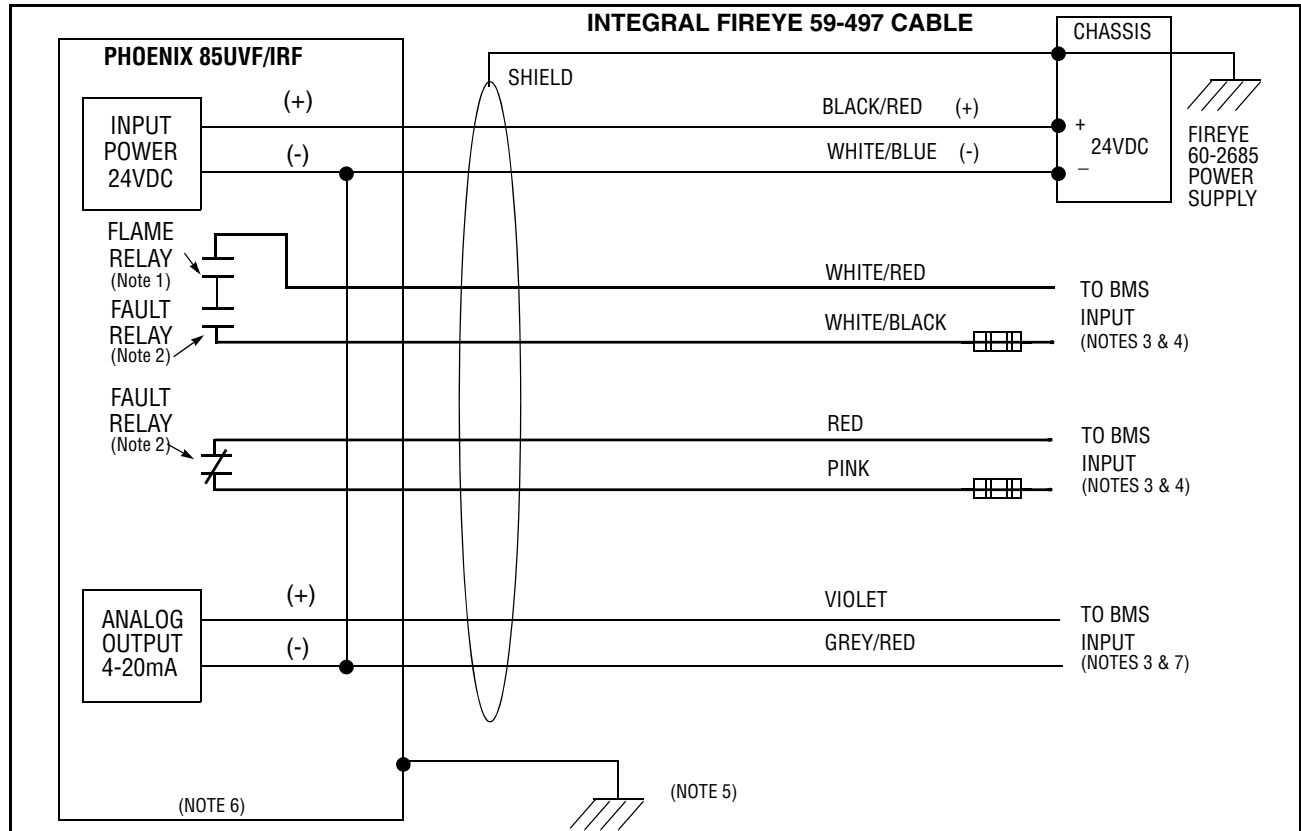

Notes:

1. Flame relay contacts are shown in de-energized (no flame) condition.
2. Fault relay contacts are shown in de-energized (fault) condition.
3. BMS = Burner Management System (by others).
4. External 2.0 Amp fuses recommended.
5. **A functional ground screw is provided on the scanner end plate. An external ground wire can be installed to comply to local codes.**
6. There are no internal customer replaceable parts.
7. Although they are at the same potential internally, the scanner's 24 vdc power source (-) must be connected to the White/Blue wire, not the Gray/Red wire.

FIGURE 7. WIRING OF PHOENIX MODEL “CEX” SCANNERS

TERMINAL	FUNCTION	INTERNAL FACTORY WIRE COLOR
TB1-1	24 Volt (-)	WHITE
TB1-2	24 Volt (+)	BLACK
TB1-3	4-20 mA (+)	VIOLET
TB1-4	4-20 mA (-)	GREY
TB2-1	FAULT RELAY	PINK
TB2-2	FAULT RELAY	RED
TB2-3	FLAME RELAY	WHITE/RED
TB2-4	FLAME RELAY	WHITE/BLACK

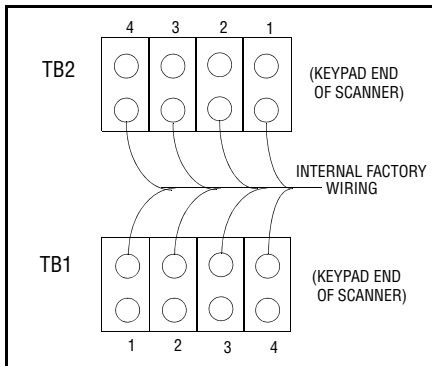

OPERATING AND PROGRAMMING THE PHOENIX FLAME SCANNER

Keypad Layout:

The Phoenix flame scanner uses a combination of informative LED status indications together with four (4) pushbuttons for programming the scanner. The layout is depicted below.

Status Indication: 12 LEDs

“Ready” (1 yellow)

“Learn Target Flame” (1 yellow)

“Learn Background Flame” (1 yellow)

“Flame On/Off” (1 yellow)

“Flame Strength” (8 orange) (also used for password entry)

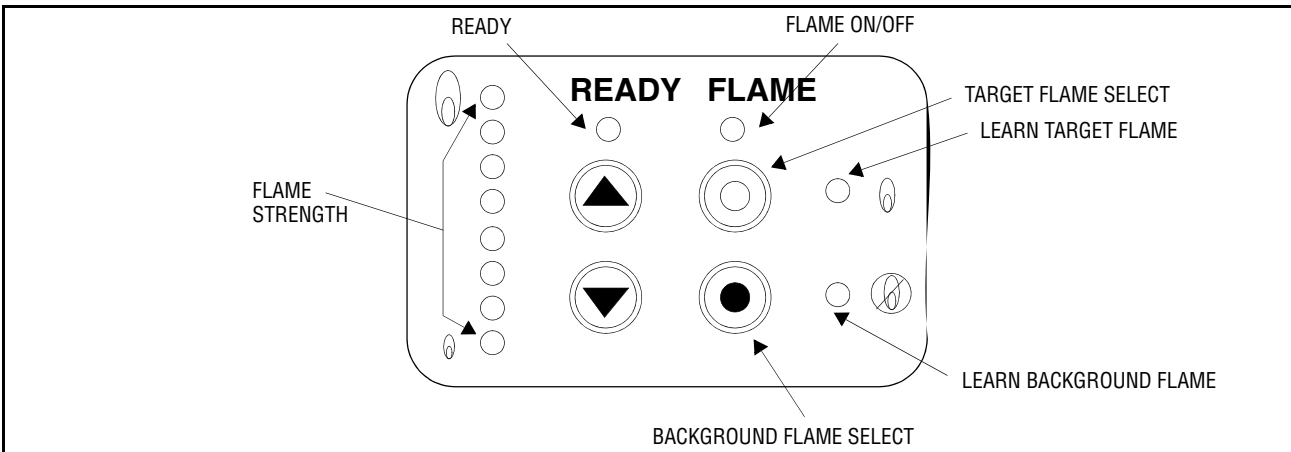

Pushbutton Functions

UP/DOWN

The UP and DOWN buttons are used to select the password prior to programming and to initiate the “learn” or store process for Target Flame and or optional Background Flame.

TARGET FLAME SELECT

The Target Select button is used to begin the “learn” or store process for the target flame. This will automatically set all the necessary switching thresholds for flame on and off recognition.

BACKGROUND FLAME SELECT (used optionally)

Should the application have background flame present, it may be desired to set up the scanner to discriminate this from the Target Flame. The background select button is used to begin the “learn” or store process for the Background Flame. This will automatically shift the “off” threshold (set during the Target Flame Select procedure) to exclude the background condition.

Pre-Commissioning Settings

FFRT Set-Up Description

Using the keypad the scanner flame failure response time can be set by the user to the desired timing. **Each unit comes from the factory pre-set at 1 second.** To change the factory default to a different FFRT see Set-Up Procedure below. To verify the current FFRT setting, press and hold the UP push button with the scanner in the normal operating mode. The “flame strength” LED set will display 1st, 2nd, 3rd or 4th LED as appropriate and these correspond to the FFRT in seconds.

FFRT Set-Up Procedure

If the Flame Failure Response Time needs modifying, follow the procedure listed below.

Press both the **Target Flame Select** and **Background Flame Select** buttons simultaneously.

Use the up button to drive the LEDs until LED number 8 (pass code) is illuminated on the flame strength LEDs right hand set.

Press both the **Target Flame Select** and **Background Flame Select** buttons simultaneously.

Press UP or DOWN push buttons to select required FFRT (the selected FFRT is displayed on the flame strength LEDs as either 1st, 2nd, 3rd or 4th). Once you have selected the correct value, Press both the **Target Flame Select** and **Background Flame Select** buttons simultaneously to store. The stored value can be displayed and checked at any time while in the normal run mode. Pressing and holding the UP pushbutton at any time will display the stored FFRT on the flame LEDs right hand set. Verify that the correct FFRT has been stored.

Commissioning the Scanner /Learning the Flame Condition

Step 1 – Enter the pass code

Press both the **Target Flame Select** and **Background Flame Select** buttons simultaneously.

Use the up button to drive the LEDs until LED number 5 (pass code) is illuminated (if you pass the required point use the down button to correct).

Press both the **Target Flame Select** and **Background Flame Select** buttons simultaneously.

LED indication at this point:

Ready = Flashing

Flame On/Off LED = OFF

Flame Learn LED =Flashing

Background Learn LED = Flashing

PASS CODE ACCEPTED

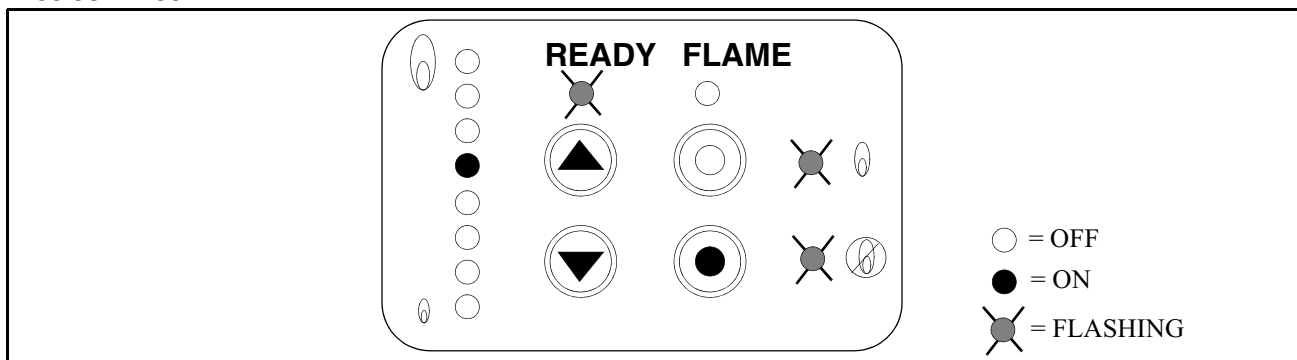

Step 2 – Learn/ Store the Target Flame

Press the Target Flame select button (the Learn Target Flame LED illuminates). Note also that the flame relay output is energized when the Target Flame Select button is depressed. This is to allow the Phoenix Scanner to signal flame present to the BMS during commissioning



WARNING: Flame must be present during scanner setup. Verify flame condition prior to depressing the Target Flame select button and energizing the flame relay output. During the setup process, run the flame at the lowest acceptable setting for flame on condition, e.g. low fire or pilot if the scanner is required to detect the condition. The scanner is at maximum gain during this mode.

Note: There is a time limit function associated with manual use of the flame relay output. If this time period of two minutes is exceeded, repeat from step one.

AIM MODE

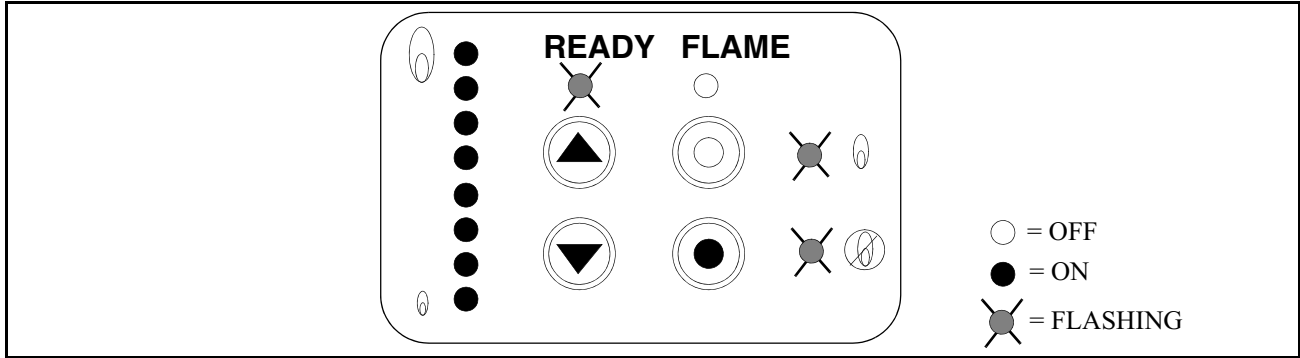

Aim mode sets the scanner to maximum gain.

Keeping the target flame button depressed, use the flame strength LEDs to adjust the scanner “aim” to get maximum signal (1 LED is the lowest, 8 LEDs are the highest). Look for 3 to 4 LEDs as a minimum.

LED indication at this point:

- Ready = Flashing
- Flame On/Off LED = ON
- Flame Learn LED = ON
- Background Learn LED = OFF
- Flame Strength LED = Flame Signal

Press either the UP or DOWN pushbutton once to learn the selected flame.

LEARN MODE

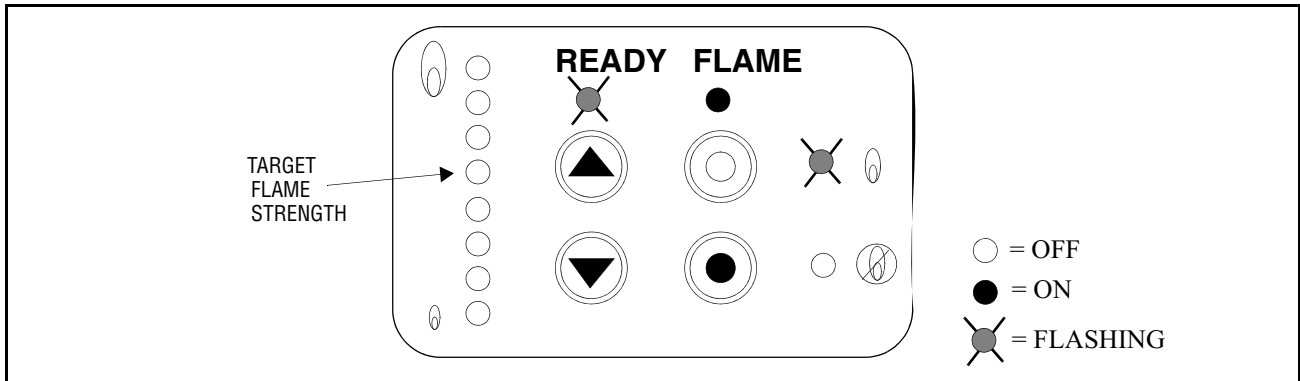

Learn Mode initially sets the scanner to minimum gains and adjusts it up to the correct level.

The Flame Strength should BRIEFLY GO BELOW 6 LEDs. If the LEDs stay at 7 or above, add orifices to minimize the signal (see page 20). If the signal strength does not drop below 6 LEDs, then decrease the size of the orifice. This may require some testing to determine the correct size.

***Note:** The “Ready” and “Target Flame” LEDs flash during the learn or store process until it has been completed.*

LEARNING THE TARGET FLAME

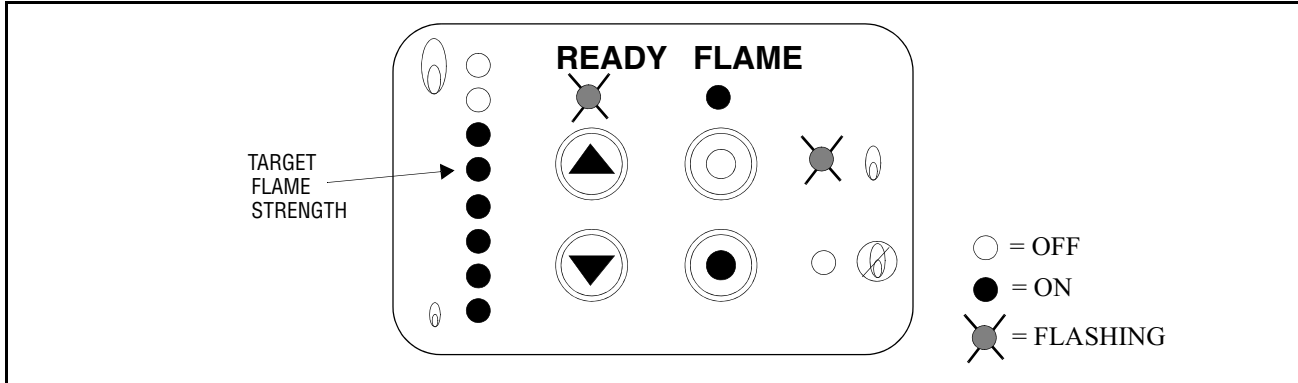

Ensure that the scanner is operating correctly prior to commissioning.

Note: Step 1 and Step 2 must be completed as a minimum to operate the scanner. Once Step 2 “Learn/Store the Target Flame” is completed the scanner will automatically set all flame switching thresholds. This would apply to a single flame application. Optionally Step 3 “Learn/Store the Background Flame” can be used to adjust the off switching threshold to discriminate a background flame condition. Refer to Step 3.

Table 2: Examples of Flame Detection Thresholds (Learning Target Flame Only)

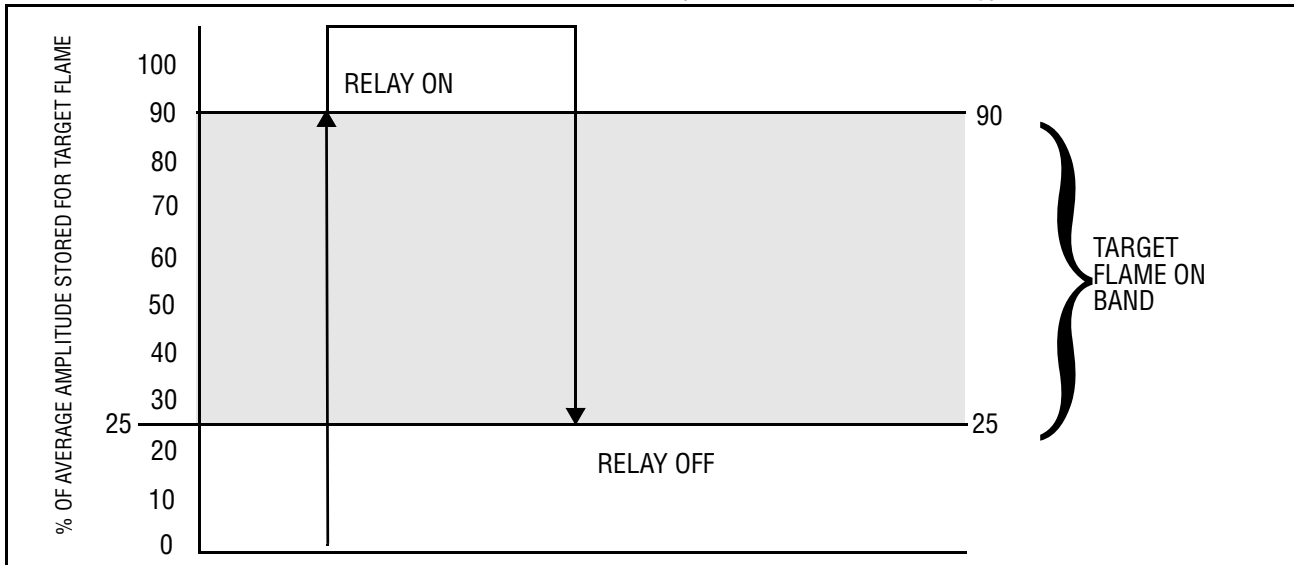

Step 3 – Learn/ Store the Background Flame (optional, see note above)

Note: Use Step 1 instructions on page 12 to enter the pass code before Step 3 can be carried out.

Press the background flame select button (the Learn Background Flame LED illuminates) to learn the selected background.

LED indication at this point:

- Ready = Flashing
- Flame On/Off LED = OFF
- Flame Learn LED = OFF
- Background Learn LED = ON

Note: The “Ready” LED flashes and the “Background Flame” LED is on steady during the learn process until it has been completed.

LEARNING THE BACKGROUND FLAME

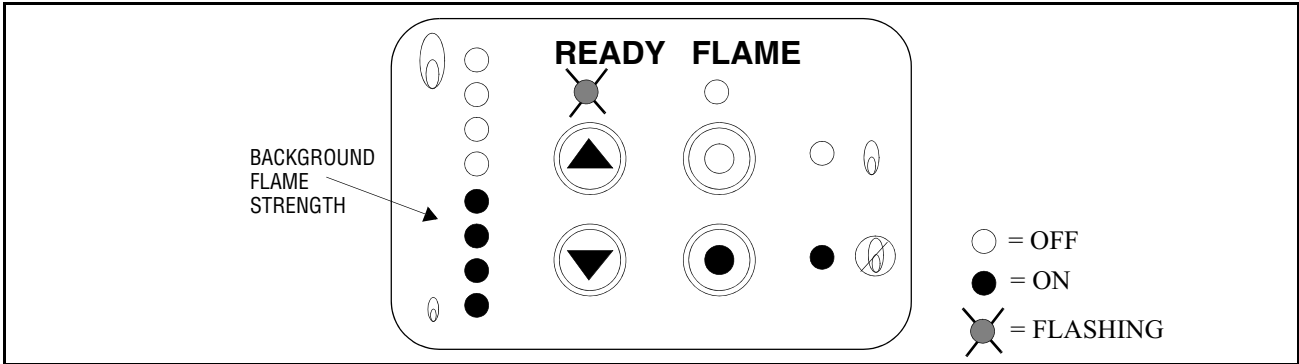
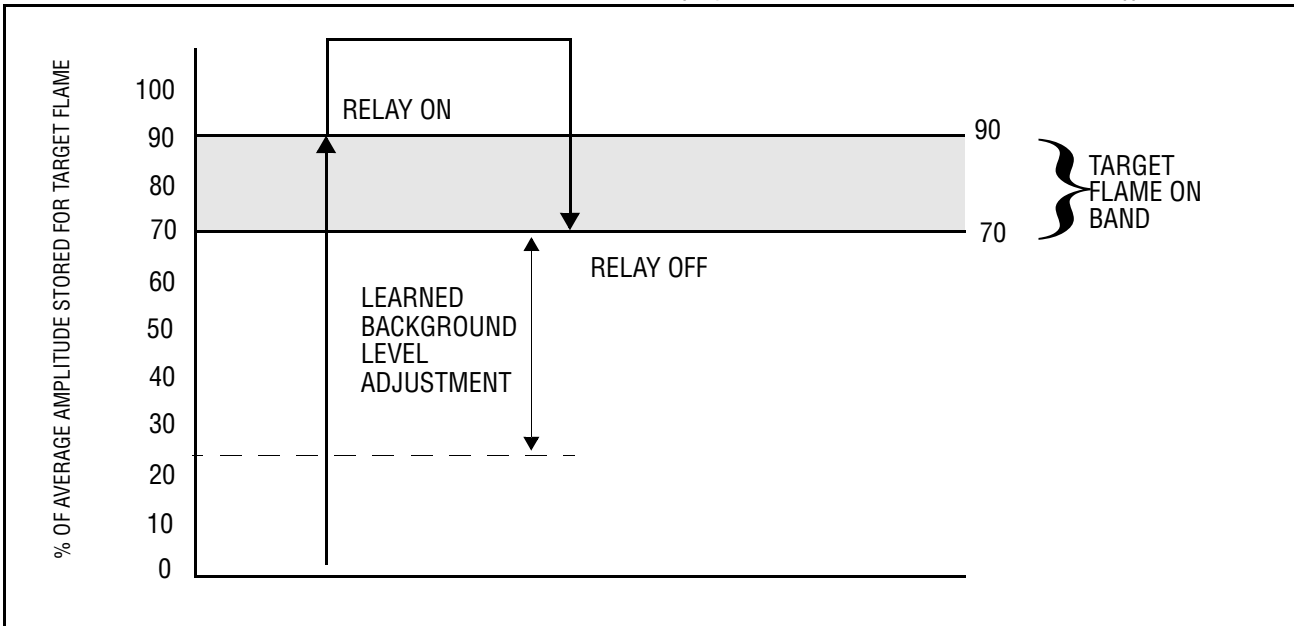

Table 3: Examples of Flame Detection Thresholds (Adjusted for Learned Background Flame)



PHOENIX SET UP PROCEDURE/LED INDICATION

TASK	ACTIONS	LED STATUS				
		Flame Strength (8)	Ready	Flame On/Off	Learn Target Flame	Learn Background Flame
RUN	(none)	All Active	ON	Active	OFF	OFF
Enter Password	Simultaneously depress: Target Flame Select and Background Flame Select buttons, then release	Disabled	ON	Active	ON	ON
	Depress and release: UP button five times	5th ON	ON	Active	ON	ON
Accept Password	Simultaneously depress: Target Flame Select and Background Flame Select buttons, then release	5th ON	FLASH	Active	FLASH	FLASH
Aim Scanner	Depress and hold*: Target Flame Select button Adjust scanner alignment for flame maximum signal then secure scanner position.	All Active	FLASH	ON *(RF is energized if Target Flame Select button is held)	ON	OFF
Learn Target Flame	Depress and release: UP or DOWN button while holding Target Flame Select button*	All Active	FLASH	ON *(RF is energized if Target Flame Select button is held)	FLASH	OFF
	Learn Target Flame completed	All Active	ON	Active	OFF	OFF
Learn Background Flame (if required)	Enter and Accept Password as described above	5th ON	FLASH	Active	FLASH	FLASH
	Depress and release: Background Flame Select button	All Active	FLASH	Active	OFF	ON
	Learn Background Flame completed	All Active	ON	Active	OFF	OFF
RUN	(none)	All Active	ON	Active	OFF	OFF



***WARNING:** Depressing *and holding* the “Target Flame Select” button during the AIM and Learn Target Flame procedures will keep the flame relay contacts closed, allowing the burner to operate without bypassing the burner management system input. During this process you must visually confirm that the flame is present. Only when the “Target Flame Select” button is released will the flame relay status be determined by the actual flame signal strength

UNDERSTANDING THE PHOENIX ERROR CODES

The eight Flame Strength LEDs provide a dual function. In the event of a scanner error condition, they provide a binary code to indicate the type of error.

Note: To reset a fault press any key. If fault does not clear, consult factory.

● = LED ON ○ = LED OFF

LED	SCANNER ERROR CODES	LED	SCANNER ERROR CODES
○ ○ ○ ○ ○ ○ ○ ○ ●	FLAME FAILURE Reserved for future use.	○ ○ ○ ○ ○ ○ ○ ○ ● ○	PLD FAILURE Logic device has failed, internal error.
○ ○ ○ ○ ○ ○ ○ ○ ● ●	SINGLE SOURCE Single flicker frequency source has been detected. This is identified as not a genuine flame.	○ ○ ○ ○ ○ ○ ○ ○ ● ○	OVER RANGE UV emissions had too much energy to learn flame condition. Use orifice or alternate sighting position.
○ ○ ○ ○ ○ ○ ○ ○ ● ●	UNDER RANGE UV emissions had too little energy to learn flame condition. Use alternate sighting position.	○ ○ ○ ○ ○ ○ ○ ○ ● ○	MIN. LOAD PW FAILURE Reserved for future use.
○ ○ ○ ○ ○ ○ ○ ○ ● ● ●	MAX. LOAD PW FAILURE Reserved for future use.	○ ○ ○ ○ ○ ○ ○ ○ ○ ○ ○	E EPROM FAILURE Internal learn memory failure. Unit cannot store values.
○ ○ ○ ○ ○ ○ ○ ○ ○ ○ ●	EXECUTION FAILURE Reserved for future use.	○ ○ ○ ○ ○ ○ ○ ○ ○ ○ ○ ● ○	CPU FAILURE Reserved for future use.



LED	SCANNER ERROR CODES	LED	SCANNER ERROR CODES
	FLAME RELAY Internal diagnostics has detected a fault on the flame relay. (Typically 24 volt supply) Note: Faults detected on the flame relay itself will operate the fault relay to remove signal to the BMS.		FAULT RELAY Internal diagnostics has detected a failure on the fault relay.
	RMEM FAILURE Reserved for future use.		IO ENABLE FAULT Internal diagnostics has detected a fault on the internal IO.
	TEMP. FAULT Scanner has exceeded maximum internal temperature of 176°F (80°C).		NEG 5 FAULT Reading is out of range.
	PLUS 5 FAULT Reading is out of range.		VREF FAULT Reference out of range
	GROUND FAULT Noise is being detected on the analog ground		3P3 FAULT 3.3 volt reading is out of range.
	SPI FAILURE Internal learn memory failure.		AIM MODE TIMEOUT Two minute maximum duration has been exceeded. Restart learning procedure, see step one.

ACCESSORIES

Orifices (see Fig. 9)

The orifice restricts the field of view (target area), reduces and maintains air flow, maintains air block and increases discrimination between flame and background radiation. The orifice is secured within the ball of a swivel mount with an orifice retainer. The orifice can also be placed within a one inch union (not provided).

The scanner should ideally sight a target area of 4 to 25 square inches (25-150 cm²) of the flame front. The flame front is a plane within the combustion space separating the region of unburned fuel from the burning fuel.

Note: There is an inverse relationship between discrimination and sensitivity.

Heat Insulating Nipple

The heat insulating nipple P/N 35-127-3 (BSP) or 35-127-1 (NPT) prevents heat transfer from the hot sight pipe to the scanner head.

Sealing Union with Quartz Window

The sealing union (60-1199) is used whenever a union or seal is required for scanner piping. The size is one inch US standard taper pipe thread (1" NPT). The sealing union has a quartz window to block off the scanner from the furnace pressure and heat. When the sealing union is used, the 1" tee/wye is used for the purge air inlet. Be sure the quartz window is properly seated to seal off the scanner. Do not overtighten union collar because damage to the window may result. For best results, hand tighten union collar.

FIGURE 8.

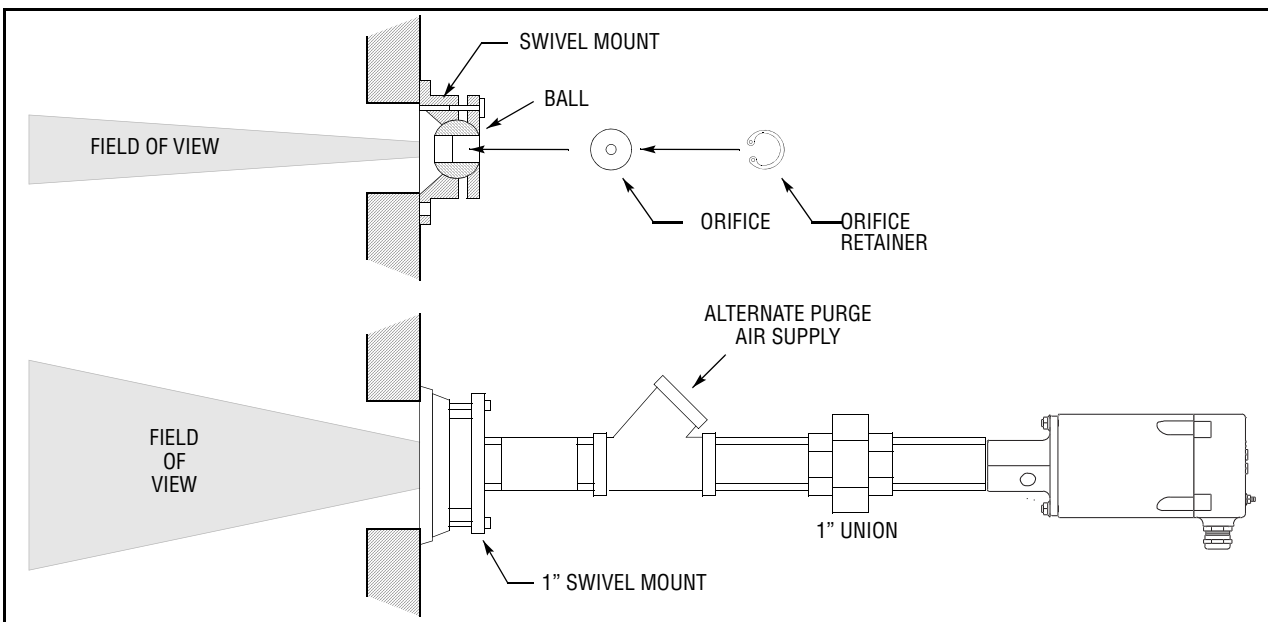

FIGURE 9.

- A. THROUGH I. ORIFICES .062 DIA TO .5 DIA
- J. 34-181 ORIFICE RETAINER
- K. 35-127-1 (NPT) HEAT INSULATING NIPPLE
35-127-3 (BSP) HEAT INSULATING NIPPLE
- L. 92-48 QUARTZ WINDOW (for 60-1199 Sealing Union shown in Fig. 5).

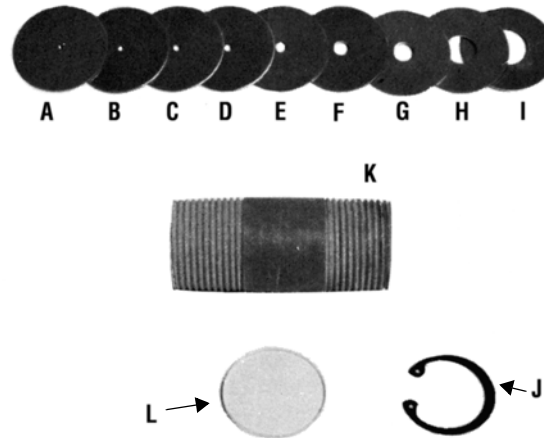
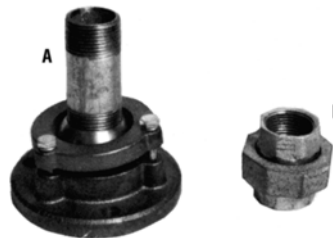

FIGURE	PART NUMBER	DESCRIPTION
9(A-J)	53-121	Orifice Set
9A	53-121-2	Orifice .062" Diameter
9B	53-121-3	Orifice .078" Diameter
9C	53-121-4	Orifice .093" Diameter
9D	53-121-5	Orifice .109" Diameter
9E	53-121-6	Orifice .125" Diameter
9F	53-121-7	Orifice .187" Diameter
9G	53-121-8	Orifice .250" Diameter
9H	53-121-9	Orifice .375" Diameter
9I	53-121-10	Orifice .50" Diameter
5	35-200	1" Wye

FIGURE 10.

- A. 60-1664-3 (NPT) SWIVEL MOUNT
60-1664-4 (BSP) SWIVEL MOUNT
- B. 60-1199 (NPT) SEALING UNION W/QUARTZ WINDOW





MAINTENANCE

1. The control and scanner should be powered at all times (except for repair, cleaning or replacement) to reduce any harmful effects of atmospheric humidity.
2. The scanner and sight pipe must be kept clean to prevent overheating and assure optical qualities.



NOTICE

When Fireeye products are combined with equipment manufactured by others and/or integrated into systems designed or manufactured by others, the Fireeye warranty, as stated in its General Terms and Conditions of Sale, pertains only to the Fireeye products and not to any other equipment or to the combined system or its overall performance.

WARRANTIES

FIREYE guarantees for *one year from the date of installation or 18 months from date of manufacture* of its products to replace, or, at its option, to repair any product or part thereof (except lamps and photocells) which is found defective in material or workmanship or which otherwise fails to conform to the description of the product on the face of its sales order. **THE FOREGOING IS IN LIEU OF ALL OTHER WARRANTIES AND FIREYE MAKES NO WARRANTY OF MERCHANTABILITY OR ANY OTHER WARRANTY, EXPRESS OR IMPLIED.** Except as specifically stated in these general terms and conditions of sale, remedies with respect to any product or part number manufactured or sold by Fireeye shall be limited exclusively to the right to replacement or repair as above provided. In no event shall Fireeye be liable for consequential or special damages of any nature that may arise in connection with such product or part.



FIREYE®
3 Manchester Road
Derry, New Hampshire 03038 USA
www.fireeye.com

CU-105
DECEMBER 9, 2008
Supersedes October 16, 2008